



**AMERICAN MICROWAVE
CORPORATION**

TEST DATA

ON

2.0 TO 18.0 GHz

SINGLE SUPPLY

LOW LOSS

VERY LOW VIDEO TRANSIENT(L/C)

15nS-ULTRA HIGH SPEED

REFLECTIVE SPST PIN DIODE SWITCH

**AMC MODEL No:
SWN-AGRA-1DR-PTTL-GAX-LVT**

Serial No: 1MS507246

**BY
AMERICAN MICROWAVE
CORPORATION**

JULY 11, 1995

7311G GROVE ROAD, FREDERICK, MARYLAND 21701 • Tel. (301) 662-4700 • Fax (301) 662-4938

**SINGLE DC SUPPLY
HIGH SPEED, REFLECTIVE
SPST PIN DIODE SWITCH**

- **ULTRA HIGH SPEED**
- **LOW INSERTION LOSS**
- **LOW VIDEO TRANSIENTS**
- **SINGLE POWER SUPPLY**

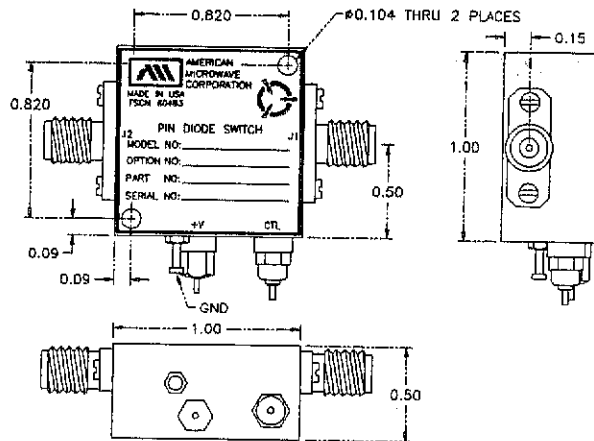

AMC MODEL No: SWN-AGRA-1DR-PTTL-GAX-LVT

SPECIFICATIONS:

- **FREQUENCY RANGE** : 2.0 GHz to 18.0 GHz
- **INSERTION LOSS** : 2.0 dB MAX.
: ≤ 0.6 dB TYP. @ 2.0 GHz
: ≤ 1.1 dB TYP. @ 8.0 GHz
: ≤ 1.2 dB TYP. @ 12.0 GHz
: ≤ 1.8 dB TYP. @ 18.0 GHz
- **ISOLATION** : ≥ 60 dB MIN.
: ≥ 90 dB TYP. @ 2.0 GHz
: ≥ 85 dB TYP. @ 8.0 GHz
: ≥ 72 dB TYP. @ 12.0 GHz
: ≥ 64 dB TYP. @ 18.0 GHz
- **VSWR** : 2.0:1
- **SWITCHING SPEED** : "RISE" : 4nS MAX., 2nS TYP.
: "FALL" : 4nS MAX., 2nS TYP.
: "ON" : 20nS MAX., 15nS TYP.
: "OFF" : 20nS MAX., 8nS TYP.
- **CONTROL** : TTL COMPATIBLE
- **VIDEO TRANSIENTS** : 130 mV Peak to Peak in a 100 MHz BW
(Typical results) : 10 mV Peak to Peak in a 20 MHz BW
Video Transients may be further reduced by decreasing the Supply Voltage by 10%
- **RF INPUT POWER** : +20 dBm Operating, 1 Watt Survival
- **DC POWER SUPPLY** : +5vdc @ 80mA MAX., 60mA TYP.
- **SIZE** : 1.0" X 1.0" X 0.5"
- **WEIGHT** : ≤ 1.0 oz



SUMMARY TEST DATA
 SWN-AGRA-1DR-PTTL-GAX-LVT
 PAGE 3

SERIAL NUMBER : 1MS507246
 TECHNICIAN : RENE AFABLE
 VOLTAGE & CURRENT DRAW : +5vdc @ 60mA

INSERTION LOSS & RETURN LOSS
 Single +5 Volt Supply

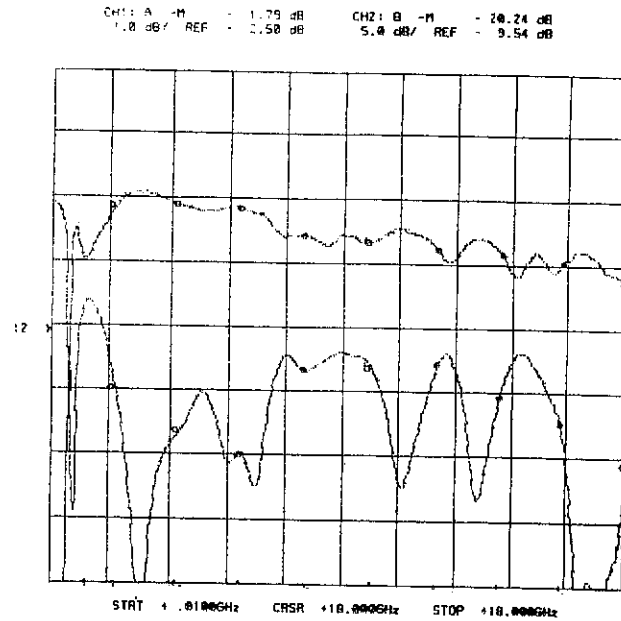

FREQUENCY	INSERTION LOSS	RETURN LOSS
1.0 GHz	1.44 dB	7.06 dB
2.0 GHz	0.57 dB	15.09 dB
4.0 GHz	0.61 dB	17.51 dB
6.0 GHz	0.68 dB	19.83 dB
8.0 GHz	1.07 dB	12.80 dB
10.0 GHz	1.13 dB	12.85 dB
12.0 GHz	1.27 dB	12.24 dB
14.0 GHz	1.31 dB	14.14 dB
16.0 GHz	1.44 dB	18.22 dB
18.0 GHz	1.79 dB	20.24 dB

JULY 11, 1995



SUMMARY TEST DATA
SWN-AGRA-1DR-PTTL-GAX-LVT
PAGE 4

SERIAL NUMBER : IMS507246
TECHNICIAN : RENE AFABLE
VOLTAGE & CURRENT DRAW : +5vdc @ 60mA

ISOLATION
Single +5 Volt Supply
AS MEASURED ON A NETWORK ANALYSER

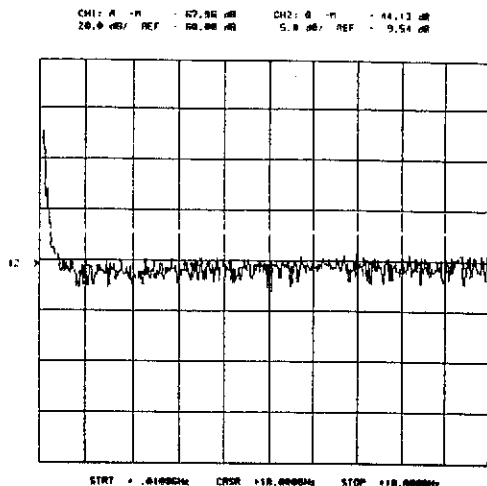

AS MEASURED ON A SPECTRUM ANALYSER

FREQUENCY	ISOLATION
1.0 GHz	76 dB
2.0 GHz	92 dB
4.0 GHz	88 dB
6.0 GHz	90 dB
8.0 GHz	86 dB
10.0 GHz	76 dB
12.0 GHz	72 dB
14.0 GHz	78 dB
16.0 GHz	72 dB
18.0 GHz	64 dB

JULY 11, 1995



SUMMARY TEST DATA
SWN-AGRA-1DR-PTTL-GAX-LVT
PAGE 5

SERIAL NUMBER : 1MS507246
TECHNICIAN : RENE AFABLE
VOLTAGE & CURRENT DRAW : +5vdc @ 60mA

SWITCHING SPEED

Single +5 Volt Supply

"RISE/FALL" TIME: 10%RF TO 90%RF & 90%RF TO 10%RF
"ON/OFF" TIME: 50%TTL TO 90%RF OR 10%RF

"ON" 15nS, "RISE" 2nS

HORIZONTAL SCALE:
10nS/DIVISION

VERTICAL SCALE:
10mV/DIVISION

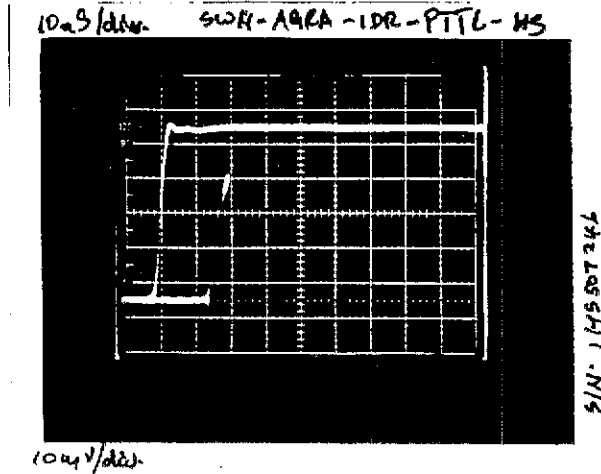

"OFF" 8nS, "FALL" 2nS

HORIZONTAL SCALE:
10nS/DIVISION

VERTICAL SCALE:
10mV/DIVISION

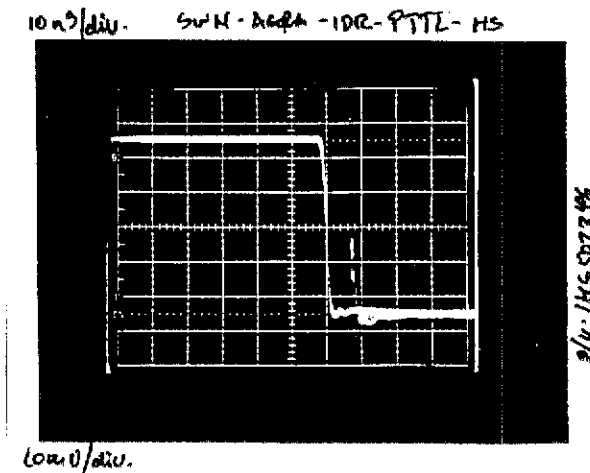

JULY 11, 1995



SUMMARY TEST DATA
SWN-AGRA-1DR-PTTL-GAX-LVT
PAGE 6

SERIAL NUMBER : 1MS507246
TECHNICIAN : RENE AFABLE
VOLTAGE & CURRENT DRAW : +5vdc @ 60mA

VIDEO TRANSIENTS
Single +5 Volt Supply

AS MEASURED IN A
100MHz BANDWIDTH

HORIZONTAL SCALE:
0.1 μ S/DIVISION

VERTICAL SCALE:
50mV/DIVISION

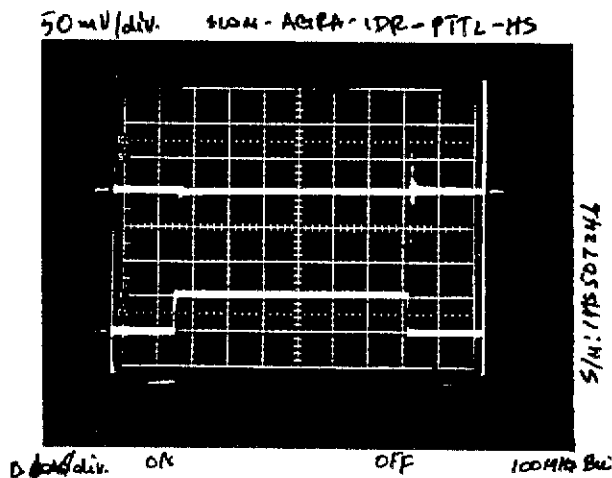

AS MEASURED IN A
20MHz BANDWIDTH

HORIZONTAL SCALE:
0.1 μ S/DIVISION

VERTICAL SCALE:
5mV/DIVISION

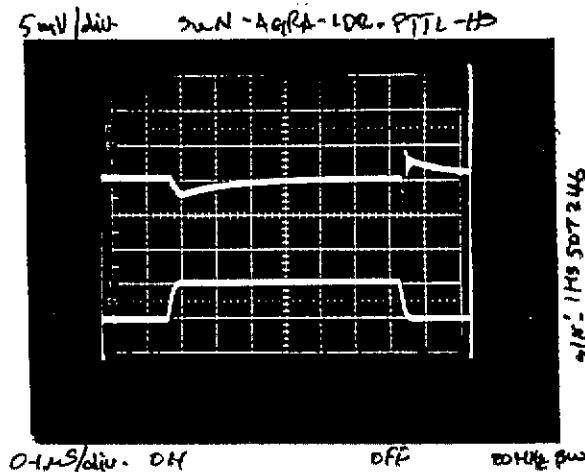

JULY 11, 1995



SUMMARY TEST DATA
SWN-AGRA-1DR-PTTL-GAX-LVT
PAGE 7

SERIAL NUMBER : 1MS507246
TECHNICIAN : RENE AFABLE
VOLTAGE & CURRENT DRAW : +5vdc @ 60mA

INSERTION LOSS, RETURN LOSS AND ISOLATION
Single +4 Volt Supply
AS MEASURED ON A NETWORK ANALYSER

INSERTION LOSS
AND
RETURN LOSS

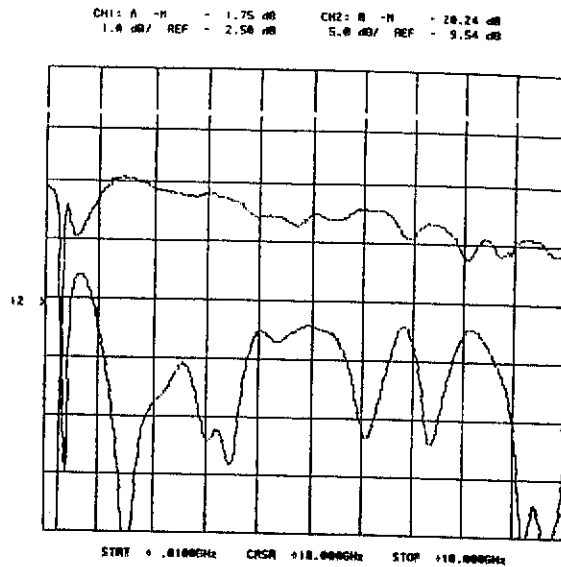

ISOLATION

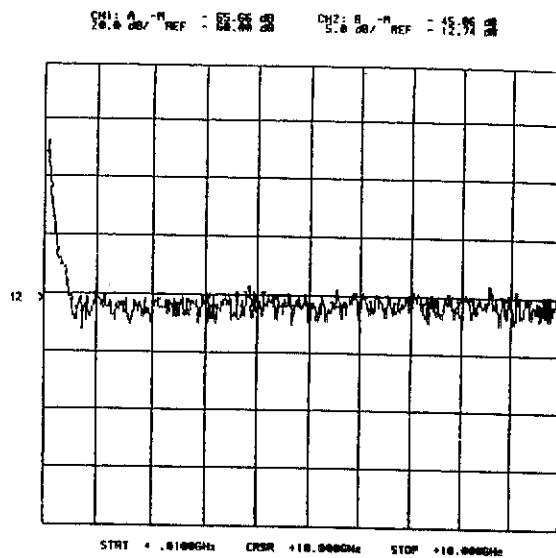

JULY 11, 1995



SUMMARY TEST DATA
 SWN-AGRA-1DR-PTTL-GAX-LVT
 PAGE 8

SERIAL NUMBER : 1MS507246
 TECHNICIAN : RENE AFABLE
 VOLTAGE & CURRENT DRAW : +5vdc @ 60mA

SWITCHING SPEED

Single +4 Volt Supply

"RISE/FALL" TIME: 10%RF TO 90%RF & 90%RF TO 10%RF

"ON/OFF" TIME: 50%TTL TO 90%RF OR 10%RF

"ON" 15nS, "RISE" 2nS

HORIZONTAL SCALE:
 10nS/DIVISION

VERTICAL SCALE:
 10mV/DIVISION

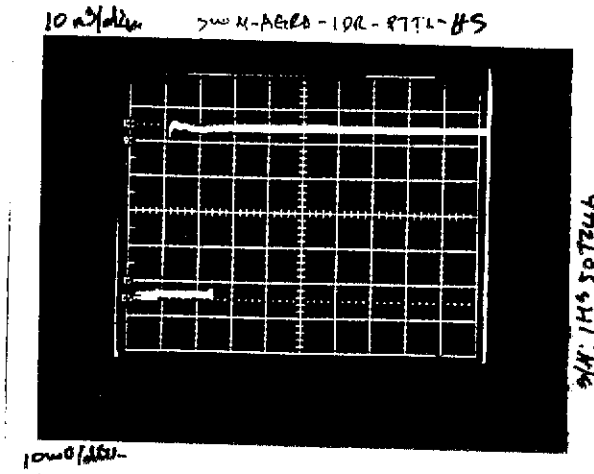

"OFF" 8nS, "FALL" 2nS

HORIZONTAL SCALE:
 10nS/DIVISION

VERTICAL SCALE:
 10mV/DIVISION

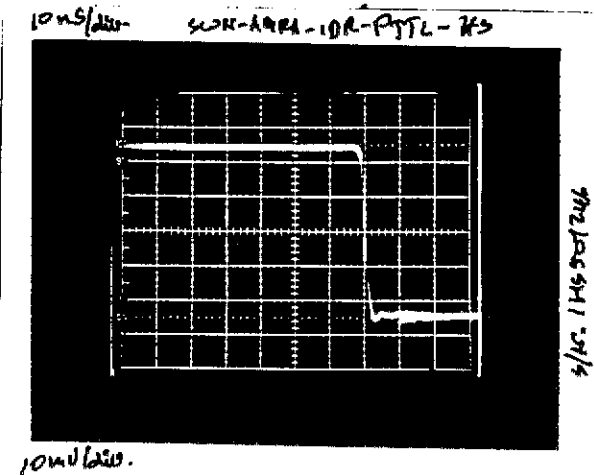

JULY 11, 1995



SUMMARY TEST DATA
SWN-AGRA-1DR-PTTL-GAX-LVT
PAGE 9

SERIAL NUMBER : 1MS507246
TECHNICIAN : RENE AFABLE
VOLTAGE & CURRENT DRAW : +5vdc @ 60mA

VIDEO TRANSIENTS
Single +4 Volt Supply

AS MEASURED IN A
100MHz BANDWIDTH

HORIZONTAL SCALE:
0.1 μ S/DIVISION

VERTICAL SCALE:
50mV/DIVISION

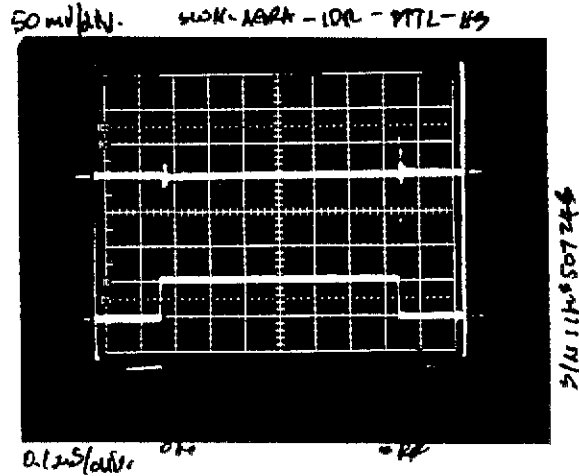

AS MEASURED IN A
20MHz BANDWIDTH

HORIZONTAL SCALE:
0.1 μ S/DIVISION

VERTICAL SCALE:
5mV/DIVISION

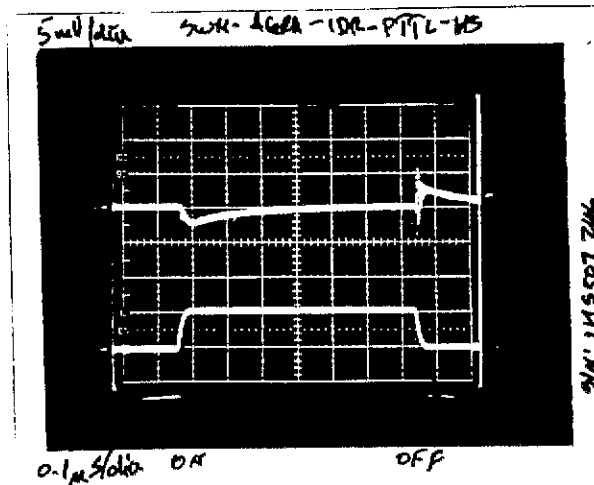

JULY 11, 1995



SUMMARY TEST DATA
SWN-AGRA-1DR-PTTL-GAX-LVT
PAGE 10

SERIAL NUMBER : IMS507246
TECHNICIAN : RENE AFABLE
VOLTAGE & CURRENT DRAW : +5vdc @ 60mA

INSERTION LOSS, RETURN LOSS AND ISOLATION
Single +3 Volt Supply
AS MEASURED ON A NETWORK ANALYSER

INSERTION LOSS
AND
RETURN LOSS

CH1: A -R - 1.78 dB CH2: B -R - 15.85 dB
1.8 dB/ REF - 2.58 dB 5.8 dB/ REF - 3.54 dB

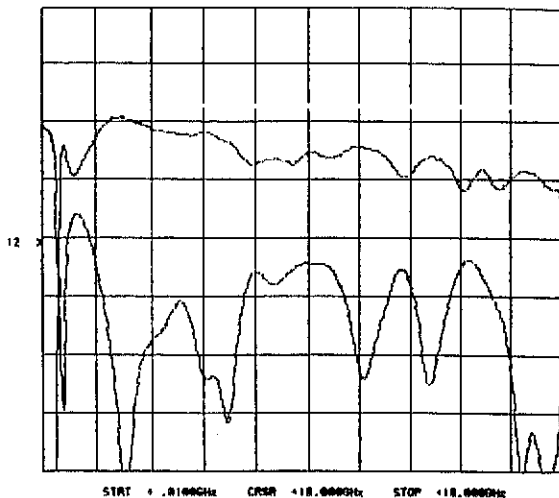

ISOLATION

CH1: A -R - 55.95 dB CH2: B -R - 52.66 dB
28.8 dB/ REF - 68.88 dB 5.8 dB/ REF - 12.74 dB

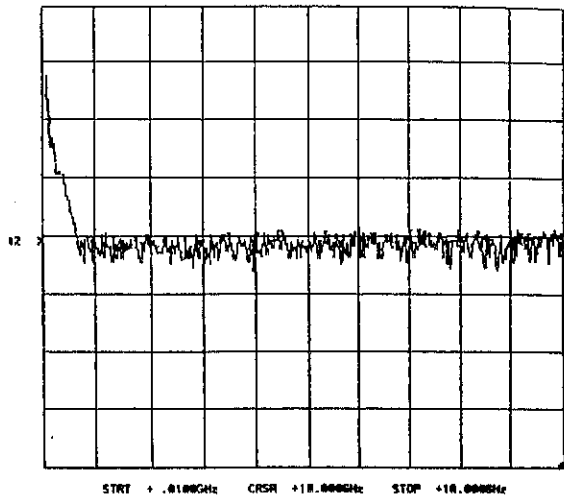

JULY 11, 1995



SUMMARY TEST DATA
SWN-AGRA-1DR-PTTL-GAX-LVT
PAGE 11

SERIAL NUMBER : 1MS507246
TECHNICIAN : RENE AFABLE
VOLTAGE & CURRENT DRAW : +5vdc @ 60mA

SWITCHING SPEED

Single +3 Volt Supply

"RISE/FALL" TIME: 10%RF TO 90%RF & 90%RF TO 10%RF
"ON/OFF" TIME: 50%TTL TO 90%RF OR 10%RF

"ON" 15nS, "RISE" 2nS

HORIZONTAL SCALE:
10nS/DIVISION

VERTICAL SCALE:
10mV/DIVISION

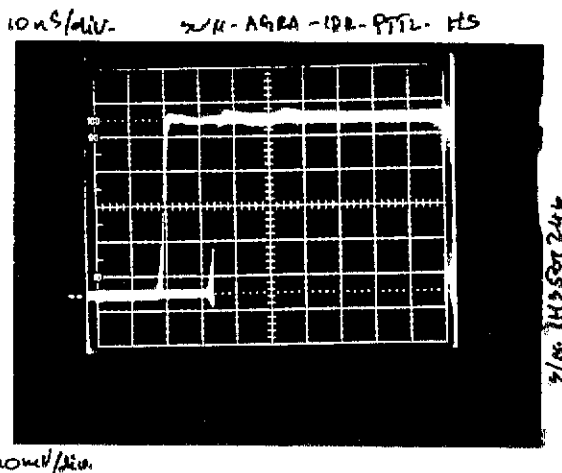

"OFF" 8nS, "FALL" 2nS

HORIZONTAL SCALE:
10nS/DIVISION

VERTICAL SCALE:
10mV/DIVISION

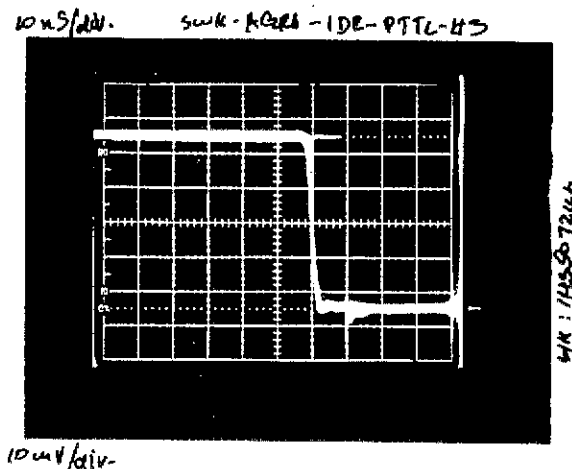

JULY 11, 1995



SUMMARY TEST DATA
SWN-AGRA-1DR-PTTL-GAX-LVT
PAGE 12

SERIAL NUMBER : 1MS507246
TECHNICIAN : RENE AFABLE
VOLTAGE & CURRENT DRAW : +5vdc @ 60mA

VIDEO TRANSIENTS
Single +3 Volt Supply

AS MEASURED IN A
100MHz BANDWIDTH

HORIZONTAL SCALE:
0.1 μ S/DIVISION

VERTICAL SCALE:
50mV/DIVISION

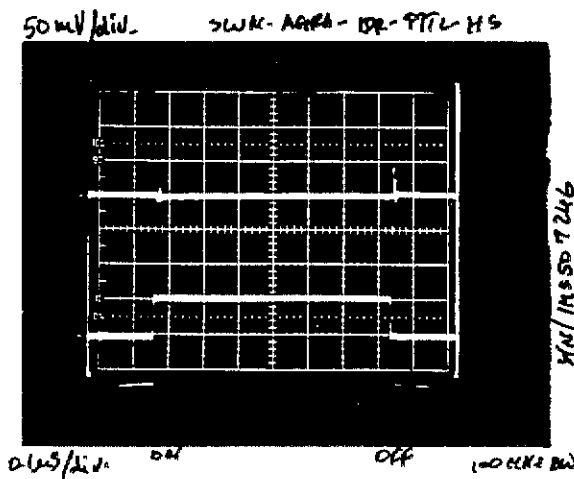

AS MEASURED IN A
20MHz BANDWIDTH

HORIZONTAL SCALE:
0.1 μ S/DIVISION

VERTICAL SCALE:
5mV/DIVISION

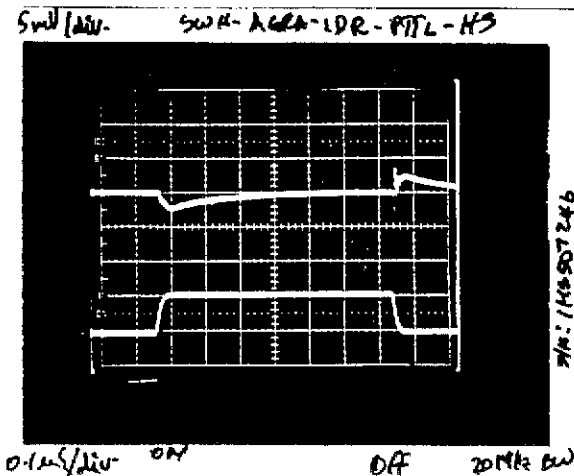

JULY 11, 1995

